

**MURO CORRESPONDIENTE A 25 METROS LINEALES**  
 - SECTOR: FRENTE A MULTICANCHA  
 - INSTALACIÓN DE MALLA ACMAFOR  
 - INSTALACIÓN DE CONCERTINA DOBLE

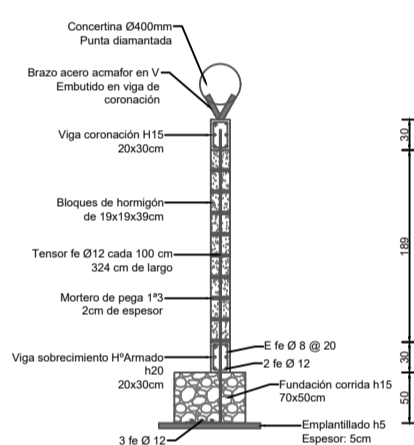

**MURO CON BLOQUES DE HORMIGÓN**  
 - 27,5 METROS LINEALES  
 - INSTALACIÓN DE CONCERTINA

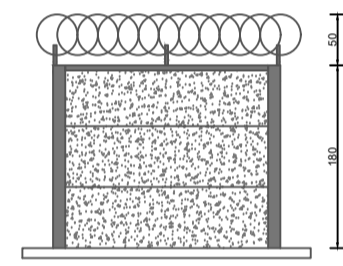

**- 30 METROS LINEALES APROX. QUE INCLUYEN: PANDERETA Y CONCERTINA.**

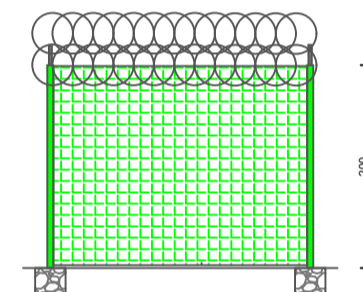

**- 285 METROS MALLA ACMAFOR - CONCERTINA DOBLE**

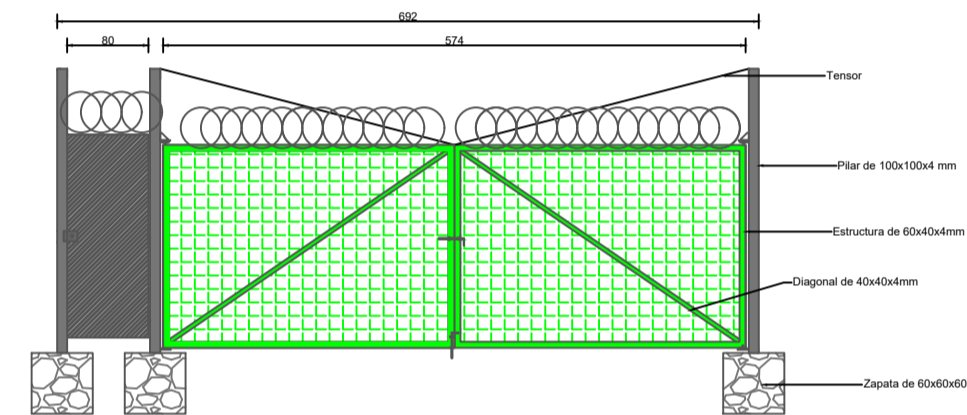

**- PORTÓN DE 7 METROS APROX.**  
 SECTOR: MULTICANCHA  
 INSTALACIÓN DE CONCERTINA

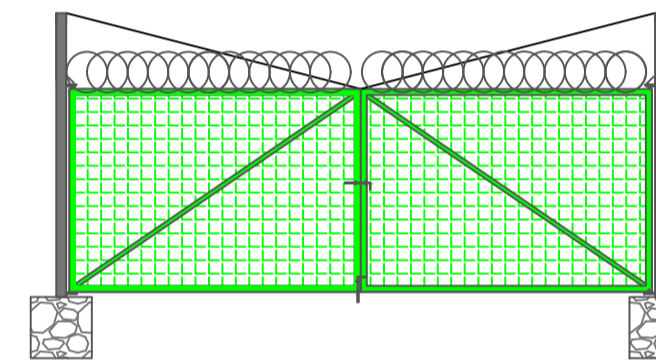

**- PORTÓN DE 6 METROS - Nº3**

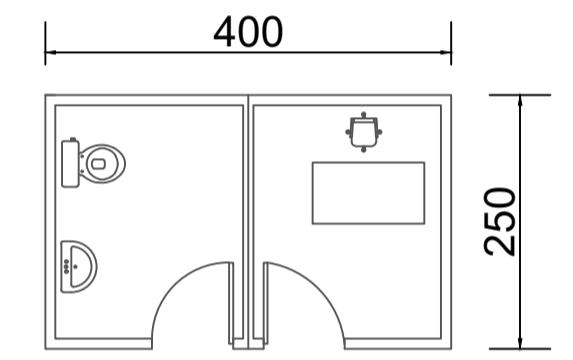

**- PLANO PLANTA DE CONTAINERS**

## - PLANOS DE DETALLES

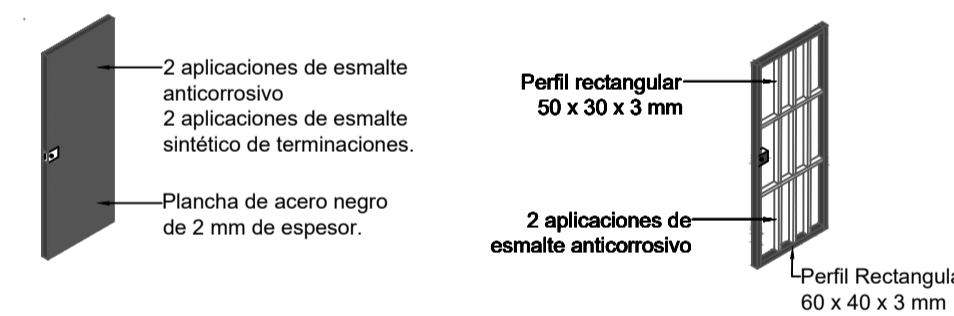

**DETALLE PUERTA DE SEGURIDAD**